



# Paramount Supply

3469 E UNIVERSITY DRIVE  
PHOENIX AZ 85034

**602-258-5599**

[gaskets@paramountsupplyphx.com](mailto:gaskets@paramountsupplyphx.com)

**CALL IT IN,  
PICK IT UP IN AN HOUR! \***



## CHILLER / HEAT EXCHANGER GASKETS

**WE CAN CUT ANY SHAPE OR SIZE:**  
1/2" x 1/2" to 60" x 60"  
thickness 1/16" - 1/2"

**RUBBER PADS/SPACERS  
FLANGE/VALVE GASKETS  
CUSTOM SHAPES/SIZES**

**Mon-Fri 6:30am - 4:pm**

\* Most orders can be cut in an hour or less.  
Special cuts or large quantities will take longer.  
Call early if you are in a rush.



**NEOPRENE, EPDM, BUNA, NSF,  
RED RUBBER, AND MUCH MORE!**

**\* IMPORTED OR DOMESTIC \***

**IF YOU CAN THINK IT  
WE CAN CUT IT**









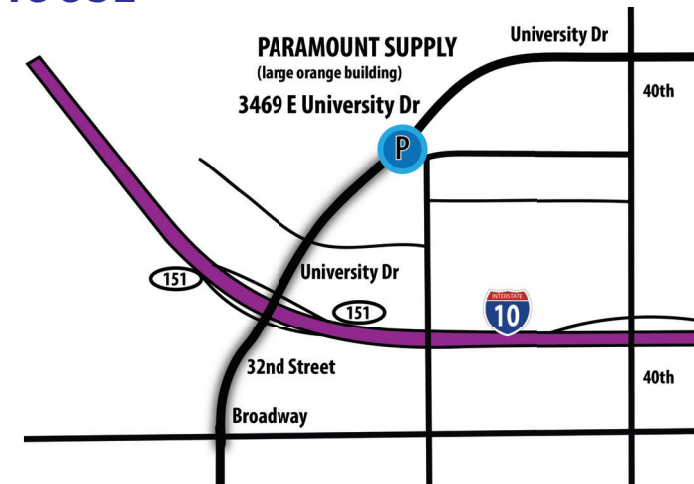

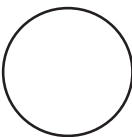
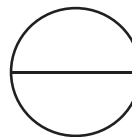

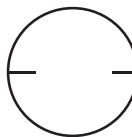
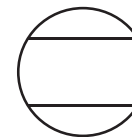
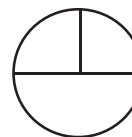
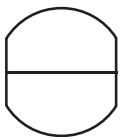

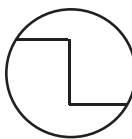
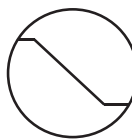
### YOUR COMPLETE INDUSTRIAL SUPPLY HOUSE

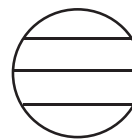
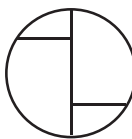
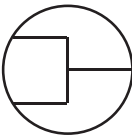
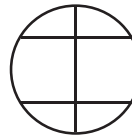
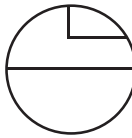
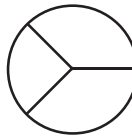
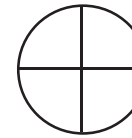
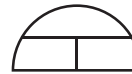
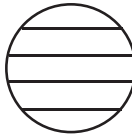
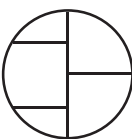
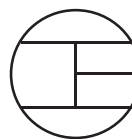
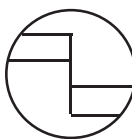
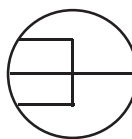
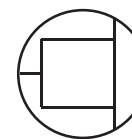
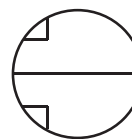
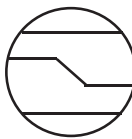
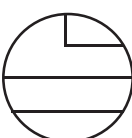
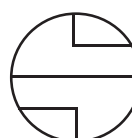
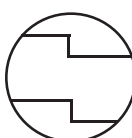
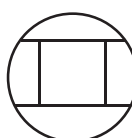
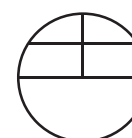
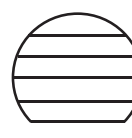

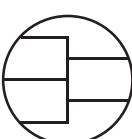
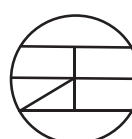
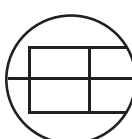
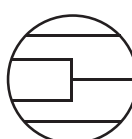
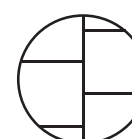
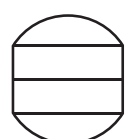
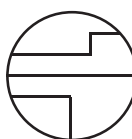
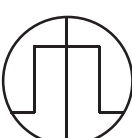
**Gaskets - Pipe - Valves - Fittings  
Gauges - Steam - Thermometers  
Water Filtration (industrial / commercial)  
Surface Repair - Grout - Filters  
Exact Saws - Specialty Coatings**

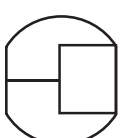
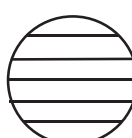
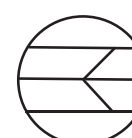
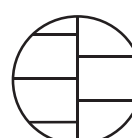
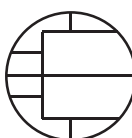
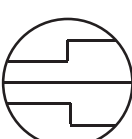
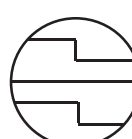
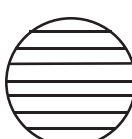
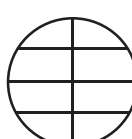
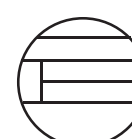
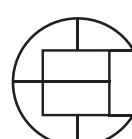
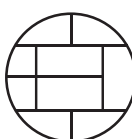
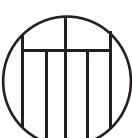
[www.paramountsupplyphx.com](http://www.paramountsupplyphx.com)

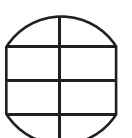
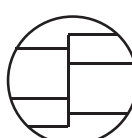
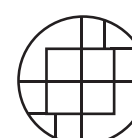
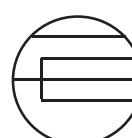

 R	 C1	 C2	 D1	 E1	 E2	 E3
 E4	 E5	 F1	 F2	 F3	 G1	 G2
 G3	 G4	 G5	 G6	 G7	 G8	 H1
 H2	 H3	 H4	 H5	 H6	 H7	 H8
 H9	 H10	 H11	 H12	 H13	 H14	 I-1
 I-2	 I-3	 I-4	 I-5	 I-6	 I-7	 I-8
 I-9	 I-10	 I-11	 I-12	 J1	 J2	 J3
 J4	 J5	 K1	 K2	 K3	 K4	 K5
 K6	 K7	 K8	 K9	 K10	 K11	

**Schedule of Standard Shapes for Heat Exchanger Gaskets**

# Measurement Examples

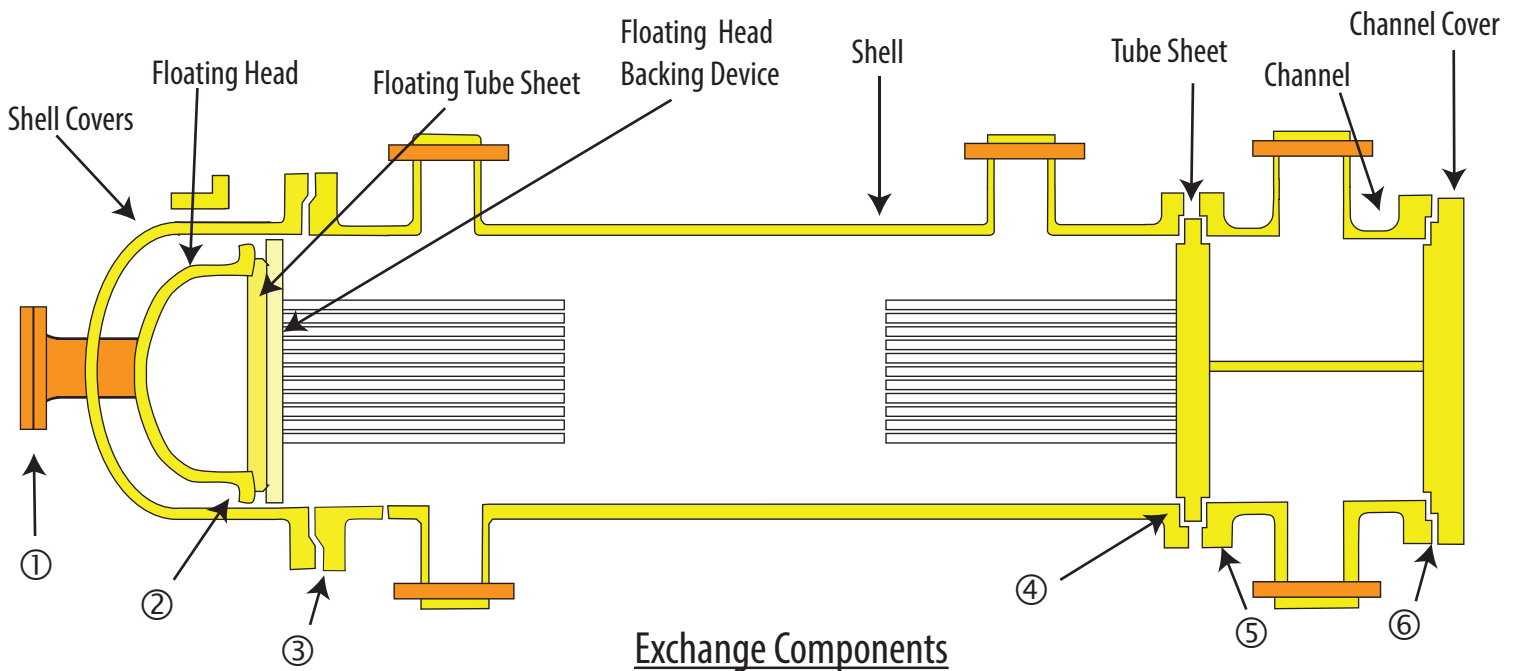

## Exchange Components

- |                          |   |
|--------------------------|---|
| 1. Handhole nozzle       | 2. Floating head to floating tube sheet |
| 3. Shell to shell cover  | 4. Tube sheet to shell                  |
| 5. Channel to tube sheet | 6. Cover to channel                     |

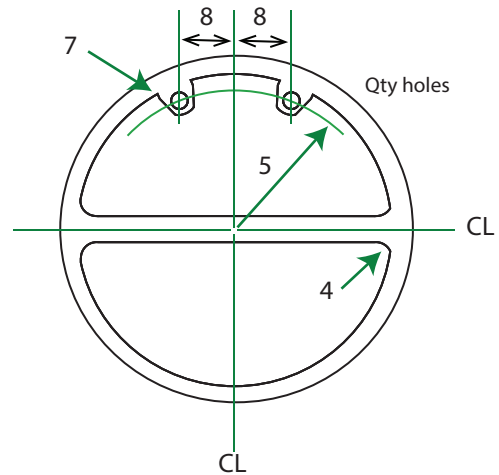
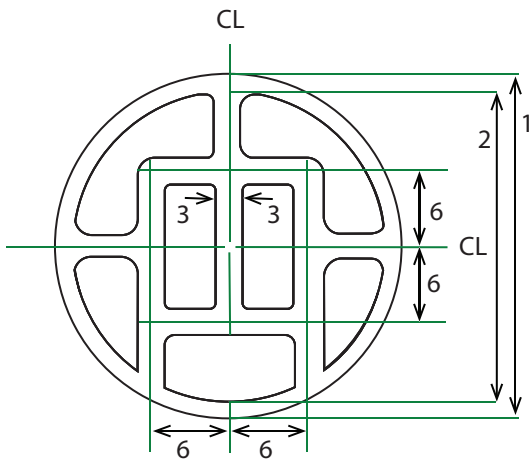

## Gasket Components

- |                |                       |                     |
|----------------|-----------------------|---------------------|
| 1. OD gasket   | 2. ID gasket          | 3. Rib width        |
| 4. Rib radius  | 5. Bolt circle radius | 6. C gasket - C rib |
| 7. bolt radius | 8. bolt holes         |                     |